

Steel for the reinforcement of concrete — Weldable reinforcing steel — Bar, coil and decoiled product — Specification

Licensed Copy: Marie-laure Chevallier ADPi (France) 07/08/2007 10:13

ICS 77.140.15; 91.080.40

Committees responsible for this British Standard

The preparation of this British Standard was entrusted by Technical Committee ISE/9, Steel for concrete reinforcement, to Subcommittee ISE/9/1, Bars, wire and fabric for concrete reinforcement, upon which the following bodies were represented:

British Coatings Federation
 British Precast Concrete Federation
 Concrete Society
 Department of Transport — Highways Agency
 Galvanizers Association
 Institution of Structural Engineers
 UK Certification Authority for Reinforcing Steels
 UK Steel Association

This British Standard was published under the authority of the Standards Policy and Strategy Committee on 30 September 2005

© BSI 2007

First published:

BS 4449: April 1969

BS 4461: March 1969

First revision:

BS 4449: May 1978

BS 4461: May 1978

Second combined version as:

BS 4449: May 1988

Third combined version as:

BS 4449: May 1997

The following BSI references relate to the work on this British Standard:

Committee reference ISE/9/1

Draft for comment

04/30109891 DC

Amendments issued since publication

Amd. No.	Date	Comments
17103	30 April 2007	See foreword

Contents

	Page
Committees responsible	Inside front cover
Foreword	ii
<hr/>	
1 Scope	1
2 Normative references	1
3 Terms and definitions	1
4 Symbols	3
5 Designations	3
6 Steelmaking and manufacturing processes	3
7 Product characteristics	5
8 Evaluation of conformity	10
9 Test methods	13
10 Identification	13
11 Verification of properties in the case of dispute	15
<hr/>	
Annex A (normative) Bond test for ribbed reinforcing steel — Beam test	16
Annex B (normative) Material not covered by a third party product certification scheme	23
Annex C (normative) Identification requirements	25
<hr/>	
Bibliography	27
<hr/>	
Figure 1 — Rib geometry example with two rows of transverse ribs	9
Figure 2 — Example of rib pattern for grade B500A	14
Figure 3 — Example of rib pattern for grade B500B	14
Figure 4 — Example of rib pattern for grade B500C	14
Figure A.1 — Dimensions of the hinge for beam type A ($d < 16$ mm)	16
Figure A.2 — Dimensions of the hinge for beam type B ($d \geq 16$ mm)	17
Figure A.3 — Beam test type A ($d < 16$ mm)	17
Figure A.4 — Beam test type B ($d \geq 16$ mm)	18
Figure A.5 — Bond test type A ($d < 16$ mm) — Reinforcement of beam specimens	20
Figure A.6 — Bond test type B ($d \geq 16$ mm) — Reinforcement of beam specimens	21
Figure C.1 — Example of manufacturer's identification mark (using widened ribs)	25
<hr/>	
Table 1 — List of symbols	4
Table 2 — Chemical composition (maximum % by mass)	5
Table 3 — Conditions of testing the mechanical properties	5
Table 4 — Characteristic tensile properties	6
Table 5 — Fatigue test conditions	6
Table 6 — Mandrel diameters for rebend test	7
Table 7 — Nominal cross-sectional area and mass per metre	8
Table 8 — Ranges for the rib parameters	9
Table 9 — Characteristic relative rib area	9
Table 10 — Absolute minimum and maximum values of tensile properties	11
Table 11 — Coefficient k as a function of the number n of test results (for a reliable failure rate of 5 % [$p = 0.95$] at a probability of 90 %)	12
Table 12 — Coefficient k as a function of the number n of test results (for a reliable failure rate of 10 % [$p = 0.90$] at a probability of 90 %)	13
Table A.1 — Series of reinforcing steel diameters for testing of bond	18
Table C.1 — Identification of the country of origin	26
<hr/>	

Foreword

This British Standard has been prepared by Subcommittee ISE/9/1, and is a revision of BS 4449:1997, which will be withdrawn on 1 January 2006. This edition incorporates a full revision of the standard. The characteristic yield strength has been increased to 500 MPa, and a third ductility class has been added, compared to BS 4449:1997.

The start and finish of text introduced by Amendment No. 1 is indicated in the text by tags **A1** **A1**.

This standard no longer covers plain round bar. For sizes up to and including 12 mm in coil, plain round wire of grade 250 MPa has been incorporated into BS 4482. For larger sizes, for dowel bar applications, reference should be made to BS EN 10025-1. For dowel bars for use in concrete pavements, reference should be made to BS EN 13877-3.

This standard has been written so that it can be used in conjunction with BS EN 10080:2005. Definitions, symbols, steelmaking and manufacturing processes, routine inspection and testing, test methods, identification of the manufacturer and technical class and verification of mechanical properties in the case of dispute are all taken from BS EN 10080:2005.

BS EN 10080:2005 does not define steel grades or technical classes, and requires that technical classes should be defined in accordance with BS EN 10080:2005, by specified values of R_e , R_m/R_e , A_{gt} , $R_{e,act}/R_{e,nom}$ (where appropriate), fatigue strength, bend performance, weldability, bond strength, tolerances and dimensions. The three steel grades in this standard conform to all of the requirements of BS EN 10080:2005.

The three grades in this standard also conform to the three recommended ductility classes of BS EN 1992-1-1:2004, although the fatigue requirements and the fatigue test conditions are retained from the previous version of this standard. The only exception to this is for grade B500A in sizes below 8 mm, where the ductility requirements specified are below those of BS EN 1992-1-1:2004.

A1 In the previous revision of this standard, bond was specified by means of a projected rib area, with a pull-out test specified as an alternative means of demonstrating compliance with the bond requirements of BS 8110-1. In this revision, bond is specified by means of a relative rib area. As an alternative, a beam test is provided in Annex A, which may be used to demonstrate compliance with Eurocode 2. Where an alternative bond test is required to demonstrate compliance with BS 8110-1, then the pull-out test may be used. This pull-out test alternative may only be applied to steels of grade B500A. **A1**

BS EN 10080:2005 contains an informative Annex ZA, which describes how that standard can be used for the purposes of CE marking of reinforcing steels. Annex ZA and 8.2, 8.3 and 8.4 of BS EN 10080:2005 relate to the role of the notified body in assessing products for an EC certificate of conformity, and as such are not included in this standard. It is not a requirement of this British Standard that materials produced to it should meet the requirements for CE marking.

Where CE marking is required for the purposes of complying with the EU Construction Products Directive, BS EN 10080:2005 applies.

It is recommended that purchasers specify reinforcing steel that has been manufactured and supplied to a recognized third party product certification scheme. 8.2 specifies the determination of the long term quality level under such a scheme. As an alternative, Annex B provides a batch testing method for material which has not been produced under such a scheme.

In BS EN 10080, the terms “rod” and “wire” are used to describe reinforcing steel in coil. In this standard, these terms have not been included to avoid the potential for confusion, particularly with wire produced to BS 4482.

This standard comes into effect on 1 January 2006.

This publication does not purport to include all the necessary provisions of a contract. Users are responsible for its correct application.

Compliance with a British Standard cannot confer immunity from legal obligations.

Summary of pages

This document comprises a front cover, an inside front cover, pages i to iii, a blank page, pages 1 to 27 and a back cover.

The BSI copyright notice displayed in this document indicates when the document was last issued.

1 Scope

This British Standard specifies requirements for ribbed weldable reinforcing steel used for the reinforcement of concrete structures. The standard covers steel delivered in the form of bars, coils and decoiled products. The standard contains provisions for three steel grades, all of 500 MPa characteristic yield strength, but with different ductility characteristics. The three grades are B500A, B500B and B500C. The weldability requirements for all grades of steel are specified in terms of the chemical composition, and in particular the carbon equivalent value.

Steel bars produced by re-rolling finished products, or by rolling material of which the metallurgical history is not fully documented or not known, are not covered by this British Standard.

NOTE Flash welds in lengths of bar are permissible under this standard, provided all the mechanical requirements are met. However, for some purposes, purchasers might specifically require bars without flash welds, and if so this ought to be stated at the time of enquiry and/or order.

2 Normative references

The following referenced documents are indispensable for the application of this document. For dated references, only the edition cited applies. For undated references, the latest edition of the referenced document (including any amendments) applies.

BS EN 1766:2000, *Products and systems for the protection and repair of concrete structures — Test methods — Reference concretes for testing.*

BS EN 10020, *Definition and classification of grades of steel.*

BS EN 10025-1, *Hot rolled products of structural steels — General technical delivery conditions.*

BS EN 10079, *Definition of steel products.*

BS EN 10080:2005, *Steel for the reinforcement of concrete — Weldable reinforcing steel — General.*

BS EN 12390-3, *Testing hardened concrete — Part 3: Compressive strength of test specimens.*

BS EN ISO 15630-1:2002, *Steel for the reinforcement and prestressing of concrete — Test methods — Part 1: Reinforcing bars, wire rod and wires.*

3 Terms and definitions

For the purposes of this British Standard the definitions in BS EN 10020 and BS EN 10079 apply, in addition to the following definitions taken from BS EN 10080:2005.

3.1

reinforcing steel

steel product with a circular or practically circular cross-section which is suitable for the reinforcement of concrete

NOTE The reinforcing steels specified using this standard are bar, coil and decoiled product.

3.2

ribbed reinforcing steel

reinforcing steel with at least two rows of transverse ribs, which are uniformly distributed over the entire length

3.3

longitudinal rib

uniform continuous protrusion parallel to the axis of the reinforcing steel

3.4

transverse rib

rib on the surface of the reinforcing steel other than a longitudinal rib

3.5

rib height

h

distance from the highest point of the rib (transverse or longitudinal) to the surface of the core, to be measured normal to the axis of the reinforcing steel

3.6

rib spacing

c

distance between the centres of two consecutive transverse ribs measured parallel to the axis of the reinforcing steel

3.7

angle of transverse rib inclination

β

angle between the axis of the transverse rib and the longitudinal axis of the reinforcing steel

3.8

transverse rib flank inclination

α

angle of the rib flank measured perpendicular to the longitudinal axis of the rib

NOTE See Figure 1.

3.9

relative rib area

f_R

area of the projection of all ribs on a plane perpendicular to the longitudinal axis of the reinforcing steel divided by the rib spacing and the nominal circumference

3.10

bar

ribbed reinforcing steel manufactured in straight lengths

3.11

coil

single length of reinforcing steel wound in concentric rings

3.12

decoiled product

reinforcing steel manufactured in coils and subsequently straightened for further processing

3.13

nominal cross-sectional area

A_n

cross-sectional area equivalent to the area of a circular plain bar of the same nominal diameter, d (i.e. $\frac{\pi d^2}{4}$)

3.14

characteristic value

value of a material or product property having a prescribed probability of not being attained in a hypothetical unlimited test series

NOTE 1 This value generally corresponds to a specific fractile of the assumed statistical distribution of the particular property of the material or product.

3.15

minimum value

value below which no test result shall fall

3.16**maximum value**

value which no test result shall exceed

3.17**batch**

quantity of bars, coils, or decoiled products of one nominal diameter and one cast produced by one manufacturer and presented for examination at any one time

3.18**standard property**

property which is part of the routine inspection and test requirements for every test unit

3.19**special property**

property which is not determined as part of the routine inspection and test requirements for every test unit (e.g. fatigue performance)

3.20**technical class**

type of reinforcing steel defined by its performance characteristics, identified by a unique product number

4 Symbols

A list of symbols used in this standard, reproduced from BS EN 10080:2005, is given in Table 1.

5 Designations

The products covered by this standard shall be designated with the following information:

- a) description of the product form (i.e. bar, coil, decoiled product);
- b) the nominal dimensions of the product;
- c) reference to this standard, and the grade.

For example, the designation for 40 mm diameter bar in 12 m lengths of grade B500B would be: "Bar 40 × 12000 BS 4449 Grade B500B".

Where products that conform to this standard are also required to meet all of the requirements of BS EN 10080:2005, for example for the purposes of CE marking, then reference to this standard should also be made in the designation. For example, the designation of the 40 mm bar described above would be: "Bar BS EN 10080 40 × 12000 BS 4449 Grade B500B".

6 Steelmaking and manufacturing processes

The melting process and type of deoxidation of the steel shall be at the discretion of the steel producer.

The manufacturing process for the production of coils and bars shall be at the discretion of the manufacturer. It shall be reported to the purchaser.

Decoiling of coil material shall be done by a machine made for this purpose.

Table 1 — List of symbols

Symbol	Description	Unit
A_n	Nominal cross-sectional area	mm ²
A_{gt}	Percentage total elongation at maximum force	%
c	Transverse rib spacing	mm
C_{eq}	Carbon equivalent value (CEV)	% by mass
C_v	Specified characteristic value	^a
d	Nominal diameter of the reinforcing steel	mm
e	Gap between rib rows	mm
f_R	Relative rib area	—
h	Rib height	mm
k	Coefficient as a function of the number of test results	—
\bar{x}	Average value of test results	^a
R_e	Yield strength	MPa ^b
R_{eH}	Upper yield strength	MPa ^b
R_m	Tensile strength	MPa ^b
R_m/R_e	Ratio tensile strength/yield strength	—
$R_{p0.2}$	0.2 % proof strength, non proportional extension	MPa ^b
s	Estimate of the standard deviation	^a
α	Transverse rib flank inclination	degrees
β	Angle of transverse rib inclination	degrees
$2\sigma_a$	Stress range in the axial load fatigue test	MPa ^b
σ_{max}	Specified maximum stress in the fatigue test	MPa ^b
σ_{min}	Specified minimum stress in the fatigue test	MPa ^b
$R_{e,act}$	Actual value of yield strength	MPa ^b
$R_{e,nom}$	Specified value of yield strength	MPa ^b
$R_{e,act}/R_{e,nom}$	Ratio actual value of yield strength/specified value of yield strength	—
a_1, a_2, a_3, a_4	Increment for calculation of batch release criteria	^a
b	Width of the beam (beam test)	mm
d_m	Mandrel diameter (beam test)	mm
F_a	Total force applied (beam test)	kN
F_i	Force in hinge and bar or wire (beam test)	kN
σ_s	Stress in the bar or wire (beam test)	MPa ^b
τ_b	Bond stress (beam test)	MPa ^b
τ_{bu}	Bond stress at maximum force (beam test)	MPa ^b
$\tau_{0.01}, \tau_{0.1}, \tau_1$	Bond stress at 0.01 mm, 0.1 mm and 1 mm slip (beam test)	MPa ^b

^a The unit depends on the property.
^b 1 MPa = 1 N/mm².

7 Product characteristics

7.1 Chemical composition

The values of individual elements and the carbon equivalent shall not exceed the limits given in Table 2.

The carbon equivalent value C_{eq} shall be calculated using the following formula:

$$C_{eq} = C + \frac{Mn}{6} + \frac{Cr + Mo + V}{5} + \frac{Ni + Cu}{15}$$

where

Mn is the percentage manganese content;

Cr is the percentage chromium content;

V is the percentage vanadium content;

Mo is the percentage molybdenum content;

Cu is the percentage copper content;

Ni is the percentage nickel content.

Table 2 — Chemical composition (maximum % by mass)

	Carbon ^a	Sulphur	Phosphorus	Nitrogen ^b	Copper	Carbon equivalent
Cast analysis	0.22	0.05	0.05	0.012	0.80	0.50
Product analysis	0.24	0.055	0.055	0.014	0.85	0.52

^a It is permitted to exceed the maximum values of carbon by 0.03 % by mass, provided that the carbon equivalent value is decreased by 0.02 % by mass.

^b Higher nitrogen contents are permissible if sufficient quantities of nitrogen binding elements are present.

During product analysis, any bar that falls outside the maximum specified limits in Table 2 shall be deemed not to conform to this British Standard.

In cases of dispute, where a product analysis falls outside the maximum limits specified in Table 2, the procedure defined in 11.2 shall be applied to determine whether the material conforms to this standard.

7.2 Mechanical properties

[A1] NOTE Bars, coils and de-coiled products should be free from features such as seams, porosity, segregation and non-metallic inclusions, etc., where they would cause the product to fail to meet the specified mechanical properties. **[A1]**

7.2.1 General

The characteristic value is (unless otherwise indicated) the lower or upper limit of the statistical tolerance interval at which there is a 90 % probability ($1-\alpha = 0.90$) that 95 % ($p = 0.95$) or 90 % ($p = 0.90$) of the values are at or above the lower limit or at or below the upper limit respectively. This quality level refers to the long-term quality level of production.

7.2.2 Conditions of testing

The conditions of testing shall conform to Table 3.

Table 3 — Conditions of testing the mechanical properties

Manufacturing and delivery condition	Condition of testing
Produced in straight lengths by hot rolling	As delivered ^a or aged ^b
Produced in straight lengths by cold working	Aged ^b
Produced as coil and delivered decoiled	Aged ^b
Produced and delivered as coil	Aged ^b

^a Aged in the case of dispute.

^b Aging method: heat the test piece to 100 °C, maintain at this temperature (± 10 °C) for a period of 60^{+15} min., and then cool in still air to room temperature. The method of heating is left to the discretion of the manufacturer.

7.2.3 Tensile properties

The specified characteristic values for the tensile properties are given in Table 4.

Table 4 — Characteristic tensile properties

	Yield strength, R_e MPa	Tensile/yield strength ratio, R_m/R_e	Total elongation at maximum force, A_{gt} %
B500A	500	1.05 ^a	2.5 ^b
B500B	500	1.08	5.0
B500C	500	$\geq 1.15, < 1.35$	7.5

^a R_m/R_e characteristic is 1.02 for sizes below 8 mm.
^b A_{gt} characteristic is 1.0 % for sizes below 8 mm.
 Values of R_e specified are characteristic with $p = 0.95$.
 Values of R_m/R_e and A_{gt} specified are characteristic with $p = 0.90$.
 Calculate the values of R_m and R_e using the nominal cross sectional area.

The absolute maximum permissible value of yield strength is 650 MPa.

For yield strength (R_e), the upper yield strength (R_{eH}) shall apply. Determine the yield strength (R_e) from the 0.2 % proof strength ($R_{p0.2}$) if a yield phenomenon is not present.

7.2.4 Fatigue strength

7.2.4.1 General

Reinforcing bars, coils and decoiled products shall be subject to fatigue testing. When submitted to axial force controlled fatigue testing, using a stress ratio ($\sigma_{min}/\sigma_{max}$) of 0.2, and stress range as given in Table 5, test samples shall survive five million stress cycles.

Table 5 — Fatigue test conditions

Bar size mm	Stress range MPa
≤ 16	200
$> 16, \leq 20$	185
$> 20, \leq 25$	170
$> 25, \leq 32$	160
> 32	150

7.2.4.2 Bars and coils

Reinforcing bars from each production site shall be subject to fatigue testing, to determine the fatigue characteristics of a particular geometrical shape and process route. The fatigue properties for each steel grade and process route shall be established at an applicable testing laboratory, initially by testing samples selected from the upper, middle and bottom of the product diameter range. At least once a year, samples shall be tested from different bars or coils of one diameter from each process route. Test samples shall be selected so that all diameters for each process route shall be tested over a five-year period.

7.2.4.3 Decoiled product

Decoiled products, from each production site, shall be subject to fatigue testing. Initially, samples shall be taken from each production site from one decoiling machine type from the largest diameter produced. At a frequency of at least once per year, samples of one diameter shall be selected for test from each production site, from one decoiling machine. Sampling shall be carried out in such a way that the combination of material manufacturing route, type of decoiler and individual machines are covered over a five-year period.

7.2.4.4 Sampling

Each test unit shall comprise ten test specimens. For each diameter, from each test unit, five bars shall be selected for test. The test specimens shall not exhibit isolated defects that are not characteristic of the product from which they are selected.

7.2.4.5 Retests

The products shall be deemed to conform to this standard if all five test pieces endure five million stress cycles.

If one of the five test pieces produces a valid failure, a further five samples from the test unit shall be tested. If one of these further samples fails the test, then the material shall be deemed not to conform to this standard, and an investigation shall be carried out and appropriate actions shall be taken. If all five further test pieces endure five million stress cycles, then the material shall be deemed to comply with this standard.

In the case of any failure, the test shall be considered invalid if it is initiated from a defect unique to the test piece or in the area within $2d$ of the testing machine grips (where d is the nominal bar diameter); in this case a further single test shall be carried out (see BS EN ISO 15630-1:2002).

7.2.5 Bend performance

Bend performance shall be demonstrated by means of the following rebend test.

Bend the test pieces through an angle of 90° , around a mandrel with a diameter not exceeding those specified in Table 6, age the test piece and then bend back by at least 20° .

After the test, the specimen shall show no sign of fracture or cracks visible to a person of normal or corrected vision.

Table 6 — Mandrel diameters for rebend test

Nominal diameter d , mm	Maximum mandrel diameter
≤ 16	$4d$
> 16	$7d$

7.3 Dimensions, mass per metre and tolerances

7.3.1 Preferred diameters, nominal cross sectional area and mass per metre

The range of nominal diameters of bars shall be 6 mm to 50 mm.

NOTE 1 The preferred millimetre nominal diameters are 8, 10, 12, 16, 20, 25, 32 and 40.

NOTE 2 If a bar smaller than 8 mm is required, the recommended diameter is 6 mm.

NOTE 3 If a bar larger than 40 mm is required, the recommended diameter is 50 mm.

The range of nominal diameters of coil and decoiled product shall be 6 mm to 16 mm.

NOTE 4 The preferred millimetre nominal diameters of coil and decoiled product are 8, 10, 12 and 16. Where coil or bar is supplied for the manufacture of welded fabric to BS 4483, then preferred millimetre nominal diameters shall include 6, 7 and 9.

NOTE 5 If coil or decoiled product smaller than 8 mm is required, the recommended diameter is 6 mm.

The values for the nominal cross sectional area and mass per metre of preferred diameters shall be as given in Table 7.

NOTE 6 The values for the nominal mass per metre are calculated from the values of the nominal cross sectional area on the basis that steels have a mass of 0.00785 kg/mm^2 per metre run.

Table 7 — Nominal cross-sectional area and mass per metre

Nominal diameter mm	Cross sectional area mm ²	Mass per metre kg
6 ^a	28.3	0.222
7 ^a	38.5	0.302
8	50.3	0.395
9 ^a	63.6	0.499
10	78.5	0.617
12	113	0.888
16	201	1.58
20	314	2.47
25	491	3.85
32	804	6.31
40	1257	9.86
50	1963	15.4

^a Preferred diameters for the manufacture of welded fabric to BS 4483 only.

7.3.2 Tolerances

The permissible deviation from nominal mass per metre shall be not more than $\pm 4.5\%$ on nominal diameters greater than 8 mm, and $\pm 6.0\%$ on nominal diameters less than or equal to 8 mm.

7.3.3 Length

The nominal length of bars shall be agreed at the time of enquiry and order.

The permissible deviation from the nominal length shall be $+100/-0$ mm; other tolerances may be agreed at the time of enquiry and order.

7.3.4 Coil mass

The nominal coil mass shall be agreed at the time of enquiry and order.

7.4 Bond strength and surface geometry

7.4.1 General

Ribbed bars are characterized by their surface geometry, by means of which bond with the concrete is achieved.

Bond property requirements of ribbed reinforcing steels according to this standard shall be based on surface geometry, or by means of the bond test provided in Annex A; bond property requirements based on surface geometry are preferred. The assessment criteria for the bond tests shall be as given in the appropriate design documents. A suitable means of factory production control based on the control of surface geometry shall be derived from the bond test results.

NOTE Required levels of bond strength, as measured in the bond test in Annex A, are given in BS EN 1992-1-1:2004, Annex C.

7.4.2 Surface geometry

7.4.2.1 General

Ribbed steels are characterized by the dimensions, number and configuration of transverse and longitudinal ribs. Bars, coils and decoiled products shall have two or more rows of transverse ribs uniformly distributed around the perimeter. Within each row the ribs shall be uniformly spaced. Longitudinal ribs can be present or not.

An example of a ribbed steel is given in Figure 1.

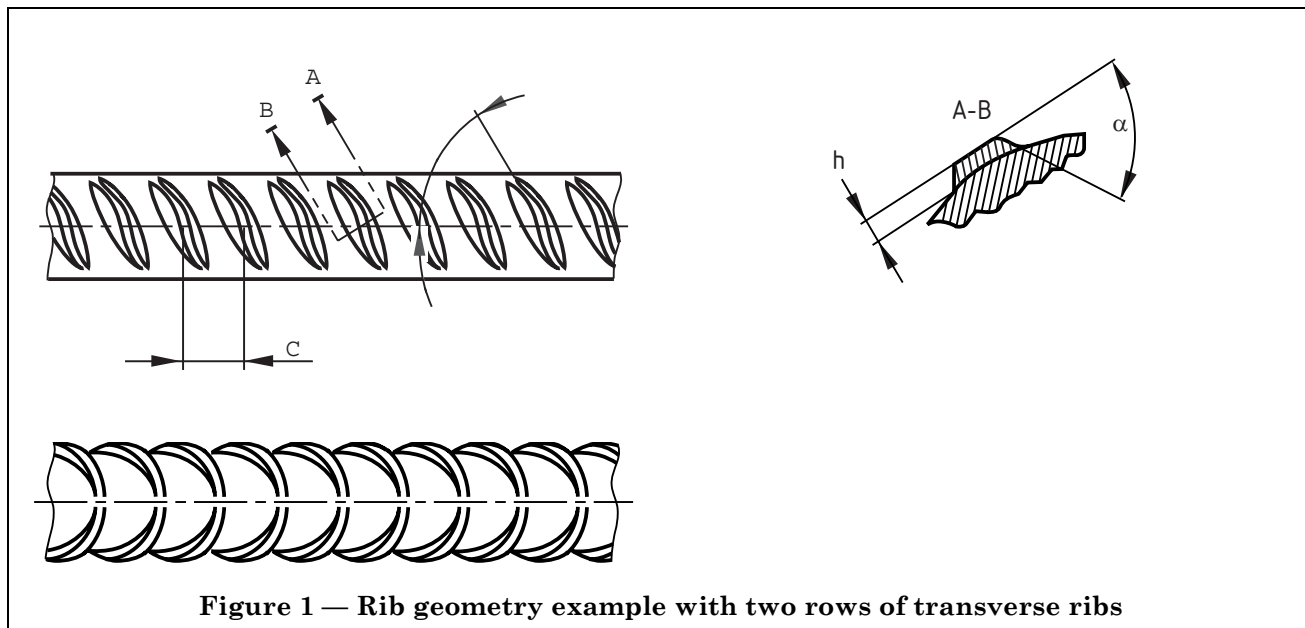

Figure 1 — Rib geometry example with two rows of transverse ribs

The values for the spacing, height and rib inclination of transverse ribs shall be within the ranges given in Table 8.

Table 8 — Ranges for the rib parameters

Rib height, h	Rib spacing, c	Rib inclination, β
$0.03d$ to $0.15d$	$0.4d$ to $1.2d$	35° to 75°

The characteristic relative rib area shall meet the requirements of Table 9. The characteristic values in Table 9 are for $p = 0.95$.

NOTE The methods for the calculation of relative rib area are given in BS EN ISO 15630-1:2002.

Table 9 — Characteristic relative rib area

Nominal bar size, d mm	Relative rib area
$d \leq 6$	0.035
$6 < d \leq 12$	0.040
$d > 12$	0.056

7.4.2.2 Transverse ribs

Transverse ribs shall approximate to a crescent shape, and merge smoothly into the core of the product.

The projection of the transverse ribs shall extend over at least 75 % of the circumference of the product, which shall be calculated from the nominal diameter.

The transverse rib flank inclination α shall be greater than or equal to 45° , and the transition from the rib to the core shall be radiused.

7.4.2.3 Longitudinal ribs

Where longitudinal ribs are present, their height shall not exceed $0.10d$, where d is the nominal diameter of the product.

8 Evaluation of conformity

8.1 Routine inspection and testing

8.1.1 General

Reinforcing steels shall be produced under a permanent system of routine inspection and testing, which shall include evaluation of specified properties, as described in 8.1.2 and 8.1.3.

8.1.2 Sampling and testing of finished products

8.1.2.1 Verification of standard properties

For the verification of standard properties, sampling and testing shall be as specified in 8.1.2.2 and 8.1.2.3.

8.1.2.2 Bars and coils

The test unit shall be the cast or part quantity of the cast.

The rate of testing shall be as follows.

- a) For chemical composition, one analysis per test unit. The chemical composition (cast analysis) of the steel shall have been determined by the steel producer.
- b) For rebend tests, nominal mass per metre and surface geometry, one test piece per test unit and nominal diameter.
- c) For tensile tests, one test piece per 30 t with at least three test pieces per test unit and nominal diameter. Where bars and coils are produced for the manufacture of welded fabric only, one tensile test piece shall be taken per 30 t produced.

Test results shall be evaluated in accordance with 8.1.3.

8.1.2.3 Decoiled products

The processor of products in coil shall ensure that the decoiled products continue to meet the specified property requirements of the appropriate grade. Inspection and testing of decoiled reinforcing bars shall include as a minimum:

- a) visual inspection for surface geometry damage of every coil processed;
- b) surface geometry measurement on at least one sample per day and produced size;
- c) tensile testing at a frequency of at least one sample per machine type (roller or spinner) per week from each of two processed sizes. The sampling shall be such that all machines and sizes are covered in a six-month period. Only one sample shall be taken from each coil.

Testing may be carried out either by the processor using its own resources (internal or external) or by the processor in co-operation with the coil manufacturer. The tests shall not be seen as release tests, but as the basis for the assessment of the long-term quality level (LTQL) as described in 8.2.

8.1.3 Evaluation of test results

8.1.3.1 Tensile properties

8.1.3.1.1 Where the characteristic value C_v is specified as a lower limit, the results shall be deemed to conform to this standard if either:

- a) all individual values are greater than or equal to the specified characteristic value C_v ; or
- b) $\bar{x} \geq C_v + a_1$

where

a_1 is 10 MPa for R_e , zero for R_m/R_e and 0 % for A_{gt} ,

and all individual values are greater than or equal to the minimum values given in Table 10.

Table 10 — Absolute minimum and maximum values of tensile properties

Performance characteristic	Minimum value			Maximum value		
	B500A	B500B	B500C	B500A	B500B	B500C
R_e , MPa	485	485	485	650	650	650
R_m/R_e	1.03 ^a	1.06	1.13	N/A	N/A	1.38
A_{gt} , %	2.0 ^b	4.0	6.0	N/A	N/A	N/A

^a 1.01 for sizes below 8 mm.
^b 0.8 % for sizes below 8 mm.

8.1.3.1.2 Where the characteristic value C_v is specified as an upper limit (i.e. for R_m/R_e of grade B500C), the results shall be deemed to conform to this standard if either:

all individual values of R_m/R_e are equal to or lower than the specified upper characteristic value of 1.35; or

- c) $\bar{x} \leq 1.35$ for R_m/R_e and all individual values for R_m/R_e are equal to or lower than the maximum value given in Table 10.

8.1.3.2 Bend performance, geometry, mass per metre

In the rebend test, all test pieces shall fulfil the requirements of 7.2.5.

If testing the surface geometry, the results shall meet the requirements of 7.4.

If testing the mass per metre, no individual value shall be outside the tolerances specified in 7.3.2.

8.1.3.3 Retests

If any test specimen fails to meet the yield strength, tensile/yield strength ratio, total elongation at maximum force, rebend or rib geometry requirements, two additional test specimens shall be taken from different bars of the same batch to undergo tests. If both additional test specimens pass the retests, the batch shall be deemed to conform to this standard. If either of the additional test specimens fails the retests, the batch shall be deemed not to conform to this standard.

8.1.4 Traceability and test reports

Delivered batches shall be identifiable and traceable to the manufacturer and to their production data. The manufacturer shall establish and maintain the records required and shall identify the products and their delivery documentation accordingly.

For each delivery, manufacturers shall supply the following information:

- the cast number and cast analysis, including all specified elements and elements used for the calculation of the carbon equivalent value;
- the carbon equivalent value;
- the results of the tensile and rebend tests;
- the mass per metre;
- the manufacturing process route; and
- the rolled on mill mark.

8.2 Assessment of the long term quality level

8.2.1 Material produced under a third party product certification scheme

The results of tests on all test units of continuous production shall be collated and statistically evaluated for R_e , A_{gt} , and R_m/R_e , taking either the number of results corresponding to the preceding six months' operation or the last 200 results, whichever is the greater.

8.2.2 Determination of the long-term quality level

The evaluation shall be carried out per nominal diameter.

The following requirement shall be satisfied for R_e , A_{gt} and R_m/R_e :

$$\bar{x} - ks \geq C_v$$

where

\bar{x} is the average value;

s is the estimate of the standard deviation of the population;

k is the coefficient listed in Table 11 for R_e and in Table 12 for A_{gt} and R_m/R_e ;

C_v is the specified characteristic value.

The foregoing is based on the assumption that the distribution of a large number of results is normal but this is not a requirement of this standard. However, the following alternative methods may be used to establish conformity of the production with the requirements of this British Standard:

- a) graphical methods including control charts;
- b) non-parametric statistical techniques.

8.2.3 Material not covered by a third party product certification scheme

Material not covered by a third party product certification scheme shall be assessed by acceptance tests on each batch (see Annex B).

Table 11 — Coefficient k as a function of the number n of test results (for a reliable failure rate of 5 % [$p = 0.95$] at a probability of 90 %)

n	k	n	k
5	3.40	30	2.08
6	3.09	40	2.01
7	2.89	50	1.97
8	2.75	60	1.93
9	2.65	70	1.90
10	2.57	80	1.89
11	2.50	90	1.87
12	2.45	100	1.86
13	2.40	150	1.82
14	2.36	200	1.79
15	2.33	250	1.78
16	2.30	300	1.77
17	2.27	400	1.75
18	2.25	500	1.74
19	2.23	1000	1.71
20	2.21	∞	1.64

Table 12 — Coefficient k as a function of the number n of test results (for a reliable failure rate of 10 % [$p = 0.90$] at a probability of 90 %)

n	k	n	k
5	2.74	30	1.66
6	2.49	40	1.60
7	2.33	50	1.56
8	2.22	60	1.53
9	2.13	70	1.51
10	2.07	80	1.49
11	2.01	90	1.48
12	1.97	100	1.47
13	1.93	150	1.43
14	1.90	200	1.41
15	1.87	250	1.40
16	1.84	300	1.39
17	1.82	400	1.37
18	1.80	500	1.36
19	1.78	1000	1.34
20	1.77	∞	1.28

9 Test methods

The tensile test for the determination of R_e , R_m/R_e and A_{gt} , the rebend test, the axial load fatigue test, the measurement of the surface geometry and the determination of the relative rib area f_R , the determination of deviation from nominal mass per metre and the methods for chemical analysis shall be in accordance with BS EN ISO 15630-1:2002. See also Table 3.

NOTE For the rebend test, it is recommended that the bending rate is approximately three revolutions per minute.

10 Identification

10.1 General

Each reinforcing steel shall have identification marks to identify the manufacturer, according to the requirements of Annex C.

Where CE marking is required, product marking shall be in accordance with BS EN 10080:2005.

10.2 Identification of steel grade

The steel grade shall be identified by the product's surface features (arrangement of the transverse ribs) as follows:

Grade B500A: bars shall have two or more series of parallel transverse ribs with the same angle of inclination and the same direction for each series. An example of rib pattern of grade B500A with four transverse rib series is given in Figure 2.

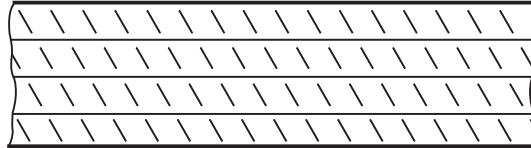

Figure 2 — Example of rib pattern for grade B500A

Grade B500B: bars shall have two or more series of parallel transverse ribs. For bars with two or three rib series, one of the series shall be at a contrary angle to the others; and for bars with four rib series, two of the series shall be at a contrary angle to the others. An example of rib pattern of grade B500B with four transverse rib series is given in Figure 3.

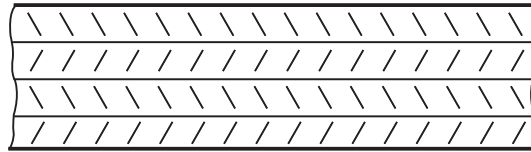

Figure 3 — Example of rib pattern for grade B500B

Grade B500C: bars shall have the same arrangement of rib series as for B500B. However, in each rib series, the ribs shall alternate between a higher and lower angle with respect to the bar axis. The difference between the angles of the different ribs and the bar axis shall be at least 10° . An example of rib pattern of grade B500C with two transverse rib series is given in Figure 4.

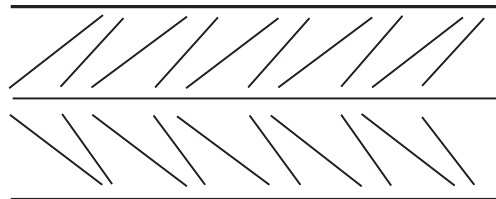

Figure 4 — Example of rib pattern for grade B500C

11 Verification of properties in the case of dispute

11.1 Mechanical properties

11.1.1 Whenever the determination of a property specified in this standard as a characteristic value creates a dispute, the value shall be verified by selecting and testing three test pieces from various pieces from the batch under examination.

If one test result is less than the specified characteristic value both the test piece and the test method shall be carefully examined. If there is a local fault in the test piece or reason to believe that an error has occurred in the test, the test result shall be ignored. In this case a further single test shall be carried out.

If the three valid test results are equal to or greater than the specified characteristic value, the batch shall be deemed to conform to this standard. If not, the requirements of **11.1.2** apply.

11.1.2 If **11.1.1** is not fulfilled, 10 additional test pieces shall be selected from different bars, coils or decoiled products in the batch.

The batch shall be deemed to conform to this standard if the average test result of the 10 test pieces is higher than the characteristic value and the individual values are higher than the minimum and lower than the maximum values given in Table 10.

If not the batch is rejected.

11.1.3 Whenever the determination of rebend characteristics is a cause for dispute, they shall be verified by selecting and testing three specimens from different bars, coils or decoiled products in the batch. If all three specimens pass the tests, the batch shall be deemed to conform, otherwise the batch shall be deemed not to conform to this British Standard.

11.2 Product analysis

If during product analysis, a single sample falls outside the maximum deviation limits for the composition range of a specified element, given in Table 2, further samples shall be selected from the remainder of the batch as follows:

- a) at least two samples from the same cast for delivered masses up to 5 t;
- b) at least five samples from the same cast for delivered masses up to 20 t;
- c) at least eight samples for delivered masses over 20 t.

If any of the further samples analysed fall outside the maximum product analysis levels given in Table 2 for any element, the batch shall be deemed not to conform to this standard.

Annex A (normative)

Bond test for ribbed reinforcing steel — Beam test

A.1 Introduction

This annex describes a method for testing the bond characteristics for ribbed bars and decoiled products to be used as reinforcing steel in concrete structures.

The beam test is intended to determine the bond of reinforcing steel and is to serve as a basis for the comparison of reinforcing bars and decoiled products of approximately the same bar or decoiled product diameter but with different surface configurations.

The test method is applicable for reinforcing steel in diameters ≤ 32 mm.

NOTE The method is based on the RILEM-Recommendation RC5, Bond test for reinforcement steel [1].

A.2 Principle of the test

A test beam is loaded by simple flexure until complete bond failure of the reinforcing steel occurs in both half-beams or until the reinforcing steel itself fails. During loading, the slip of the two ends of the reinforcing steel is measured.

The beam used for the test consists of two parallelepipedal reinforced concrete blocks interconnected at the bottom by the reinforcing steel of which the bond is to be tested, and at the top by a steel hinge. The dimensions of the two blocks and the hinges are determined by the diameter of the reinforcing steel to be tested. The test is illustrated in Figure A.1, Figure A.2, Figure A.3 and Figure A.4.

The dimensions of the test beams depend on the nominal diameter of the reinforcing steel for which the bond is to be determined. For nominal diameters less than 16 mm, a beam specimen of type A is used and for nominal diameters equal to or larger than 16 mm, a beam specimen of type B is used (see Figure A.3 and Figure A.4).

NOTE Experience of testing bars with diameters larger than 32 mm is limited. To use the test method of this annex for such large diameters, a type testing program should be performed to evaluate the applicability of the test method.

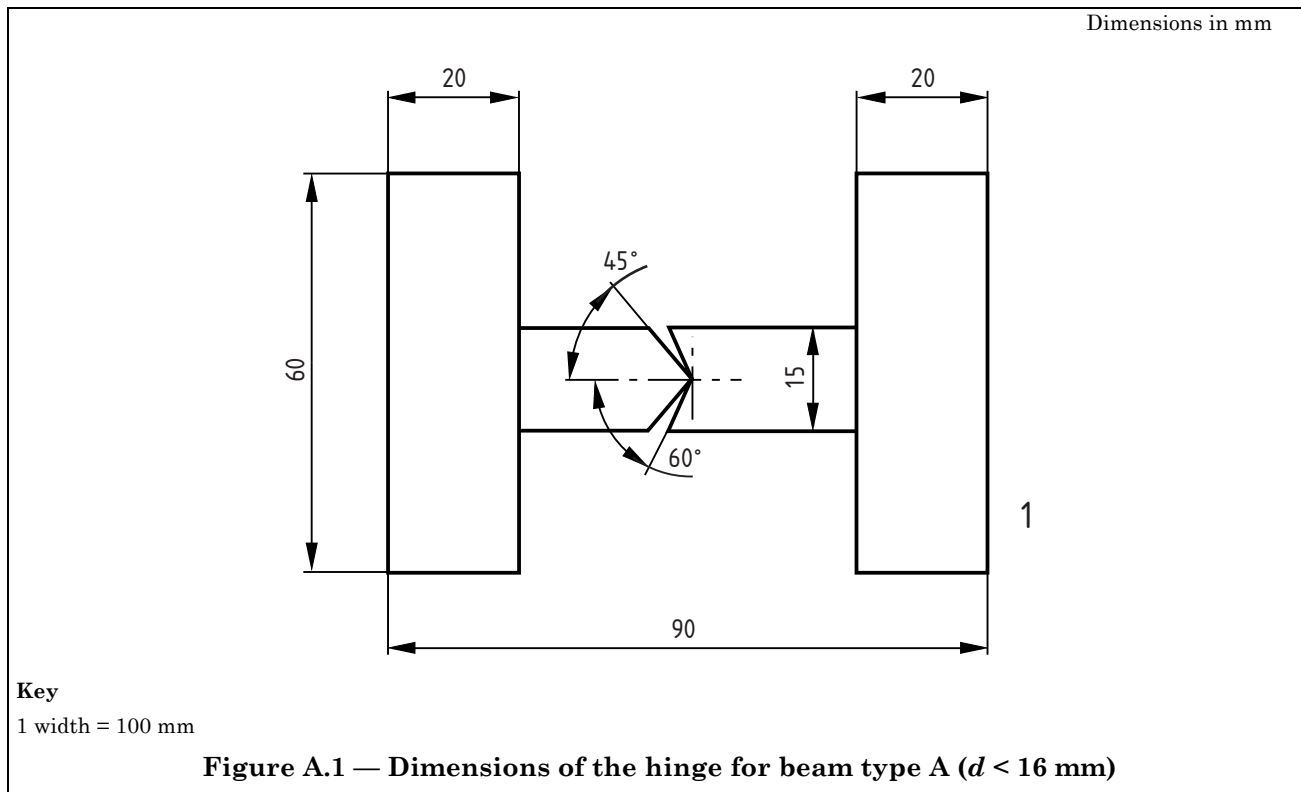

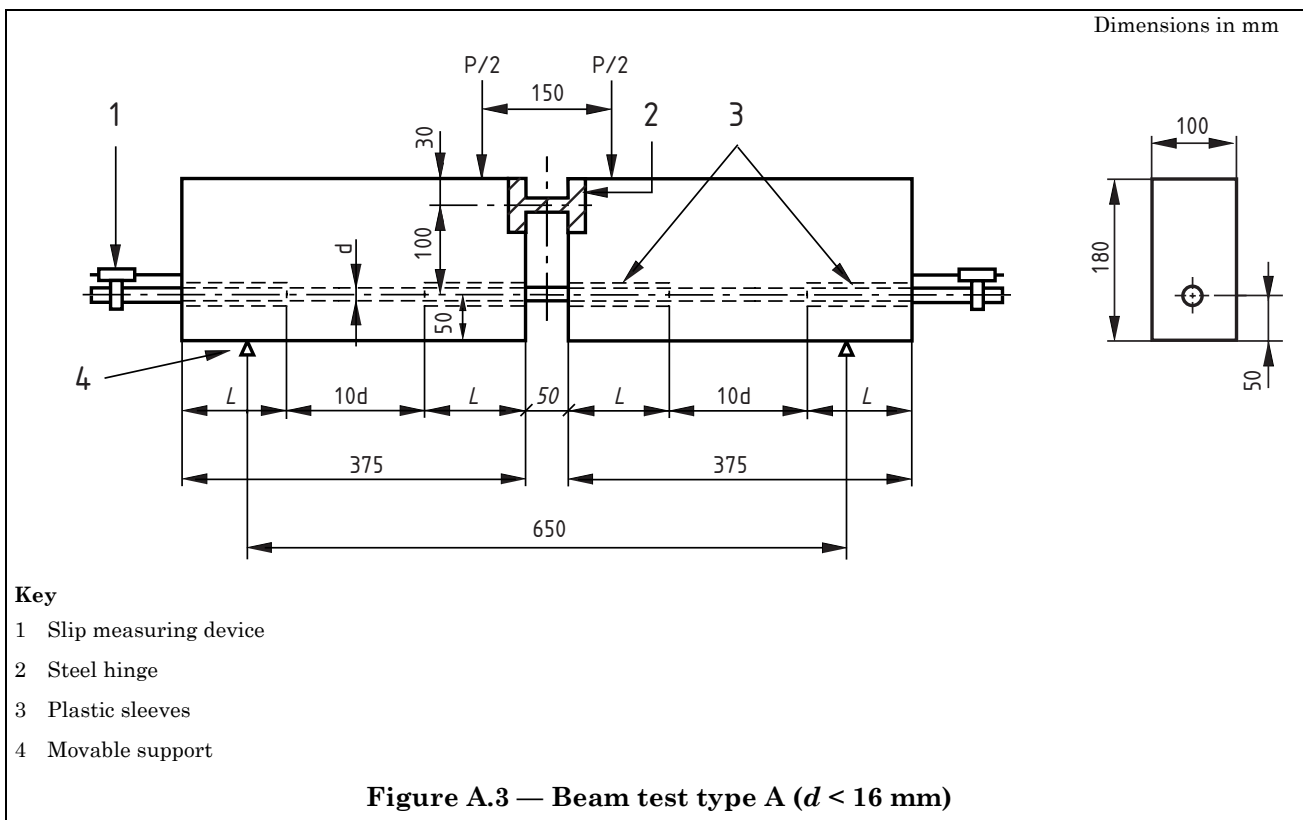
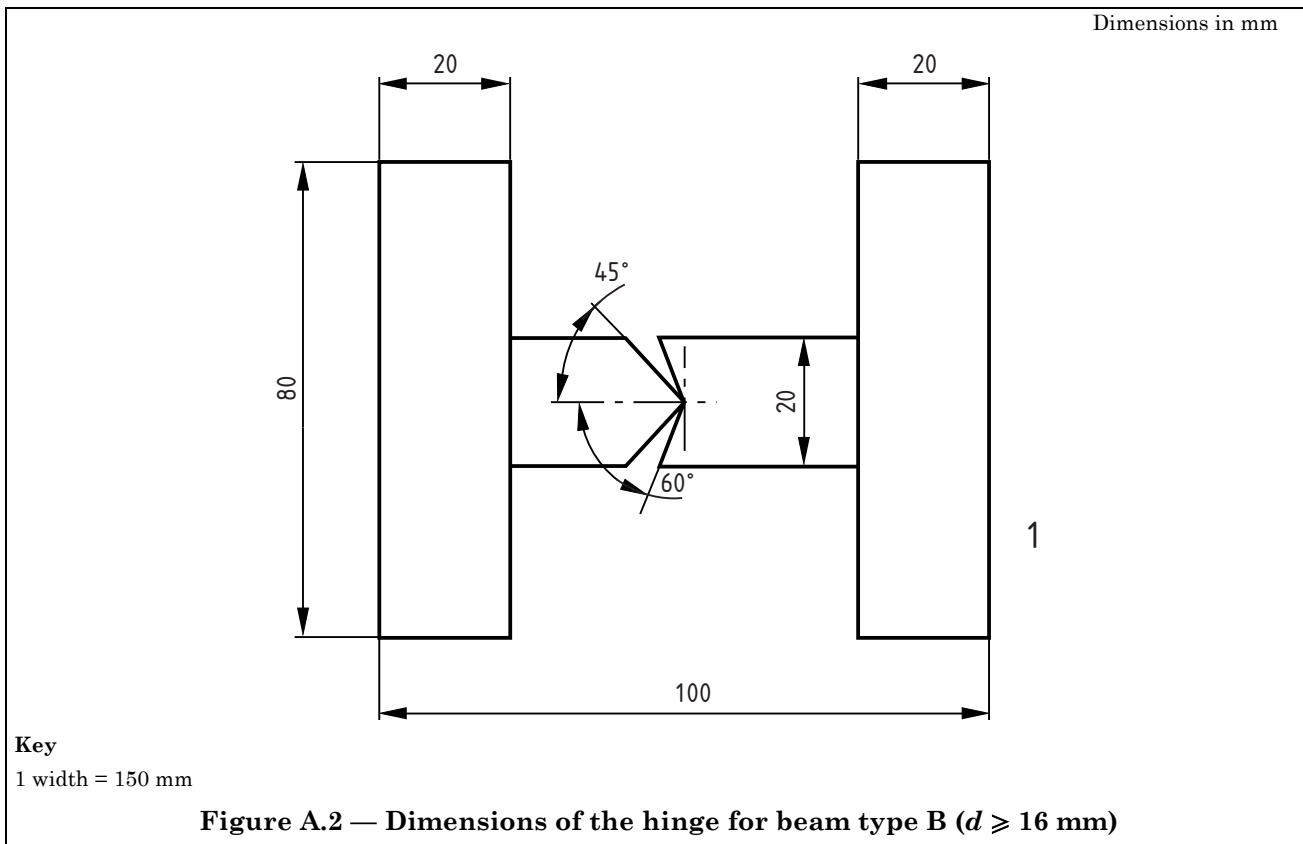

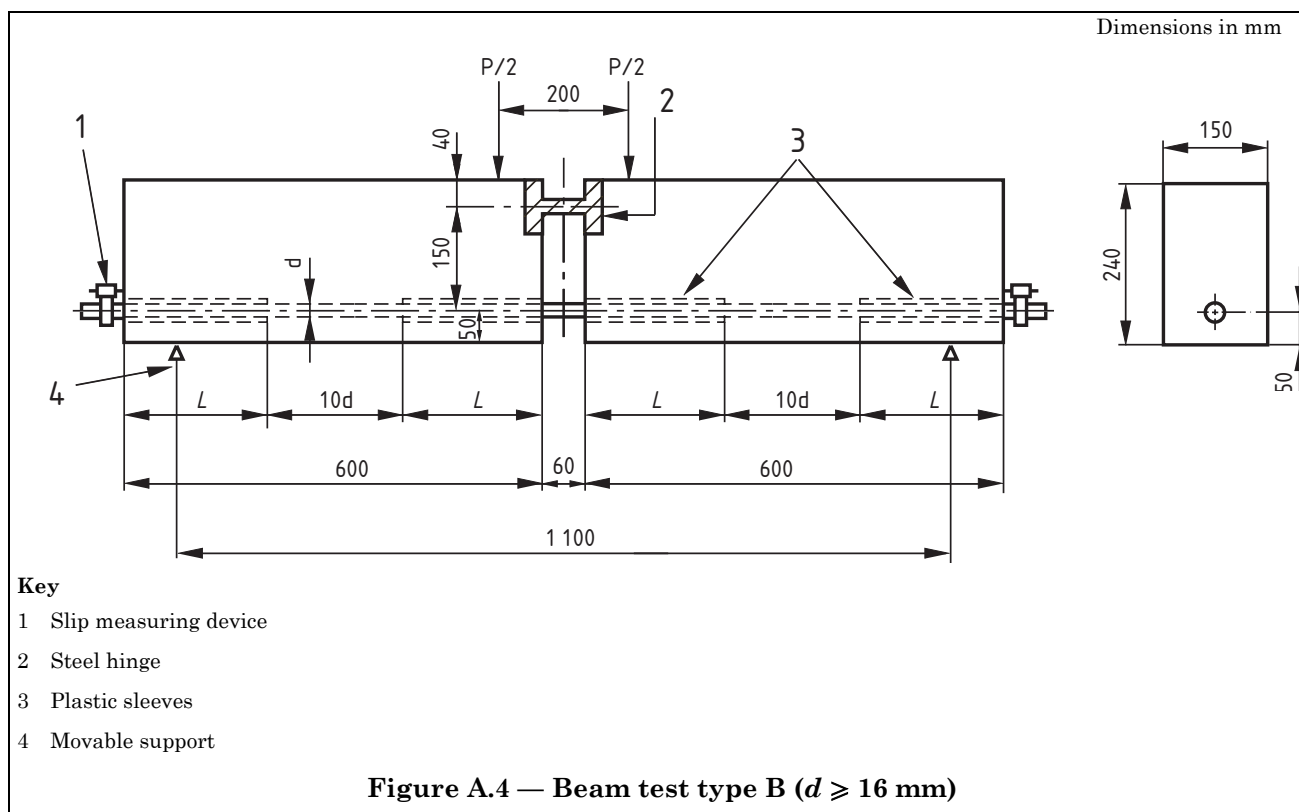

A.3 Samples and specimens

If various sizes of the same technical class of reinforcing steel and the same surface configuration are to be tested, they may be grouped into series. All diameters within a group shall have the same configuration with regard to ribs. A suitable grouping is shown in Table A.1.

NOTE To have the same surface configuration implies that the relationship between rib height/bar-or-decoiled product diameter and rib spacing/bar-or-decoiled product diameter as well as the rib inclination is the same.

Table A.1 — Series of reinforcing steel diameters for testing of bond

Denomination of the series	Range of nominal diameters, d mm	Representative nominal diameter of the series mm
Small diameters	$d \leq 10$	8
Medium diameters	$10 < d \leq 20$	16
Large diameters	$20 < d \leq 32$	32
Very large diameters	$32 < d \leq 50$	Each size to be tested

Twenty-five beam tests shall be carried out for each series and type of surface geometry with the representative diameter of the series. Samples shall be selected to minimize the variation in surface configuration within a series. If all samples are not taken from the same bar or decoiled product, then they should be taken from as few bars or decoiled products as possible.

If the representative diameter of a series is not manufactured, the largest diameter produced in the series shall be tested.

If reinforcing steels with the same surface geometry but with different specified yield strength are to be characterized, the tests shall be carried out with the product having the highest specified yield strength.

The surface geometry of the reinforcing steel to be used in the tests shall be described in accordance with BS EN 10080:2005 and measured in accordance with BS EN ISO 15630-1:2002. All the parameters required to calculate the relative rib area shall be measured and recorded.

A.4 Test equipment

A.4.1 *Moulds for the test beams*, made of steel, cast iron or any other non-absorbent material which does not react with the components of the concrete. Watertightness and dimensions should be maintained after use.

A.4.2 *Steel hinges*, formed from two pieces of steel in a T shape, as shown in Figure A.1 and Figure A.2, which interconnect the transversal interior faces of the two blocks. The width of the hinge is the same as the width, b , of the beam.

A.4.3 *System for regulating forces*, fitted to the mechanism for applying forces, which enables them to be increased continuously, within the limits described in A.6.

A.4.4 *Force application system*, for applying forces perpendicular to the face of the beam specimen.

The mechanism for applying forces shall consist of steel rotating knife-edges or roller bearings; two to support the beam specimen and another two for loading.

A.4.5 *Instruments for measuring forces*, with an accuracy of at least 1 % of the test result.

The reading device shall give an indication of the maximum force reached during the test.

A.4.6 *Instruments for measuring slip*, accurate to ± 0.01 mm.

A.5 Preparation of samples

A.5.1 Reinforcing steel to be tested

The test bar shall be in the “as manufactured” condition without loose millscale, preferably entirely free from rust and, if necessary, carefully degreased with carbon tetrachloride (CCl_4) or ethylene trichloride (C_2HCl_3). The test bar shall be without any machining. If the test bar is corroded, the conditions of the bar shall be described in the test report and possibly supported by photographs of the surface.

The bar shall not be cleaned in any way that might change its roughness.

Test pieces taken from coil shall be straightened according to BS EN ISO 15630-1:2002, Clause 4, prior to testing.

A.5.2 Auxiliary reinforcement

Auxiliary reinforcement should have the same strength and surface characteristics as the reinforcing steel to be tested. Figure A.5 and Figure A.6 detail the components for the auxiliary reinforcement.

A.5.3 Plastic sleeves

Sleeves used to avoid the adherence of the concrete to the reinforcing steel to be tested shall be of plastic. These sleeves shall be rigid so as not to become deformed during the test.

A.5.4 Concrete

A.5.4.1 General

The concrete for the beam specimen as well as the cylindrical test pieces shall be produced, placed and stored according to BS EN 1766:2000 with the qualifications given in A.5.4.2.

A.5.4.2 Strength class of concrete

The concrete shall be either of Type C(0,70) of BS EN 1766:2000 with a compression strength target value of (25 ± 5) MPa, or of Type C(0,45) of BS EN 1766:2000 with a compressive strength target value of (50 ± 5) MPa, measured on 150 mm × 300 mm cylindrical specimens and tested according to BS EN 12390-3.

If not otherwise agreed the tests shall be performed with concrete Type C(0,70) of BS EN 1766:2000.

NOTE It is recommended that the test pieces for 25 tests are prepared in 5 lots or mixes, making 5 specimens from each lot.

The age of the concrete shall not be less than 21 days and not more than 35 days.

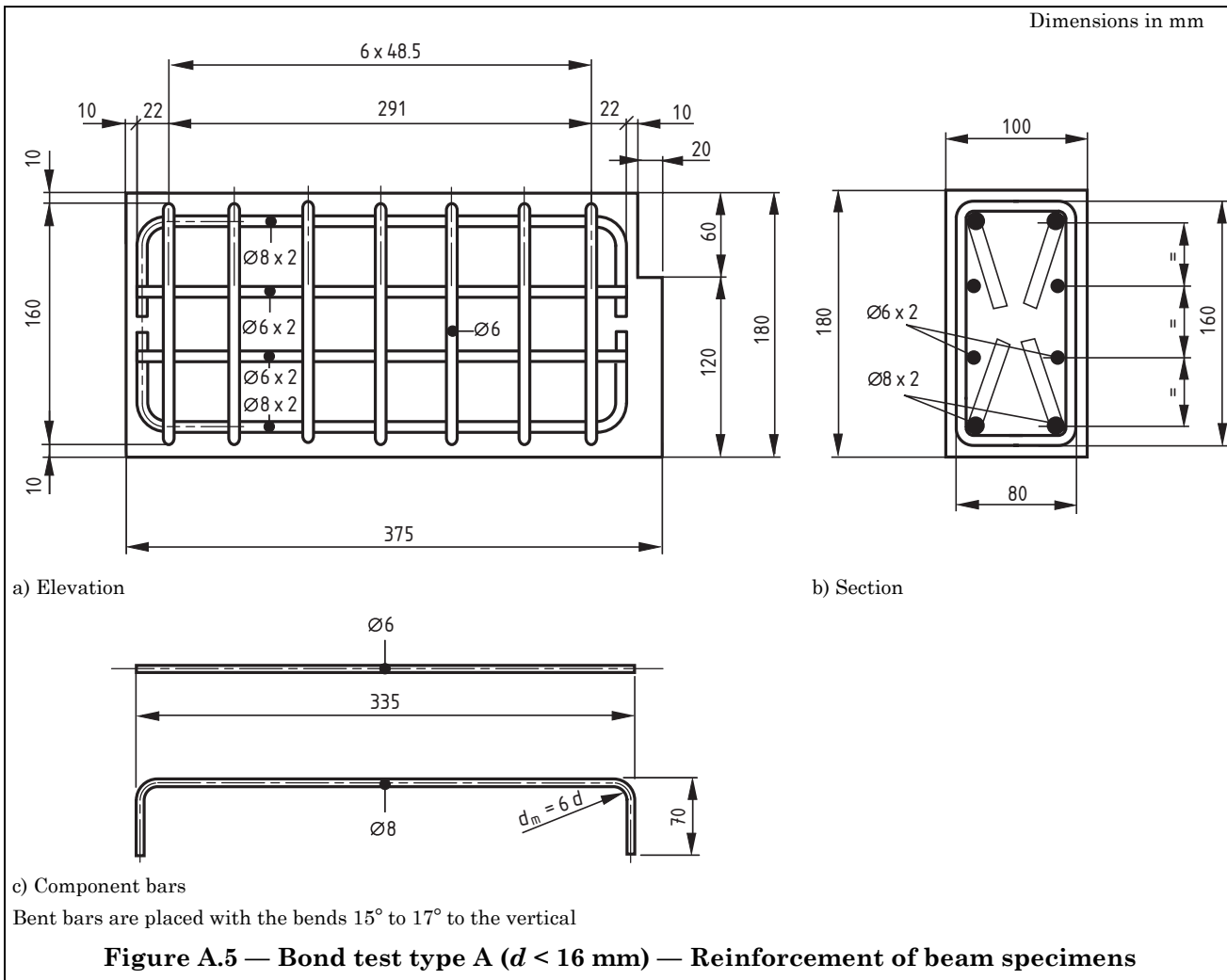

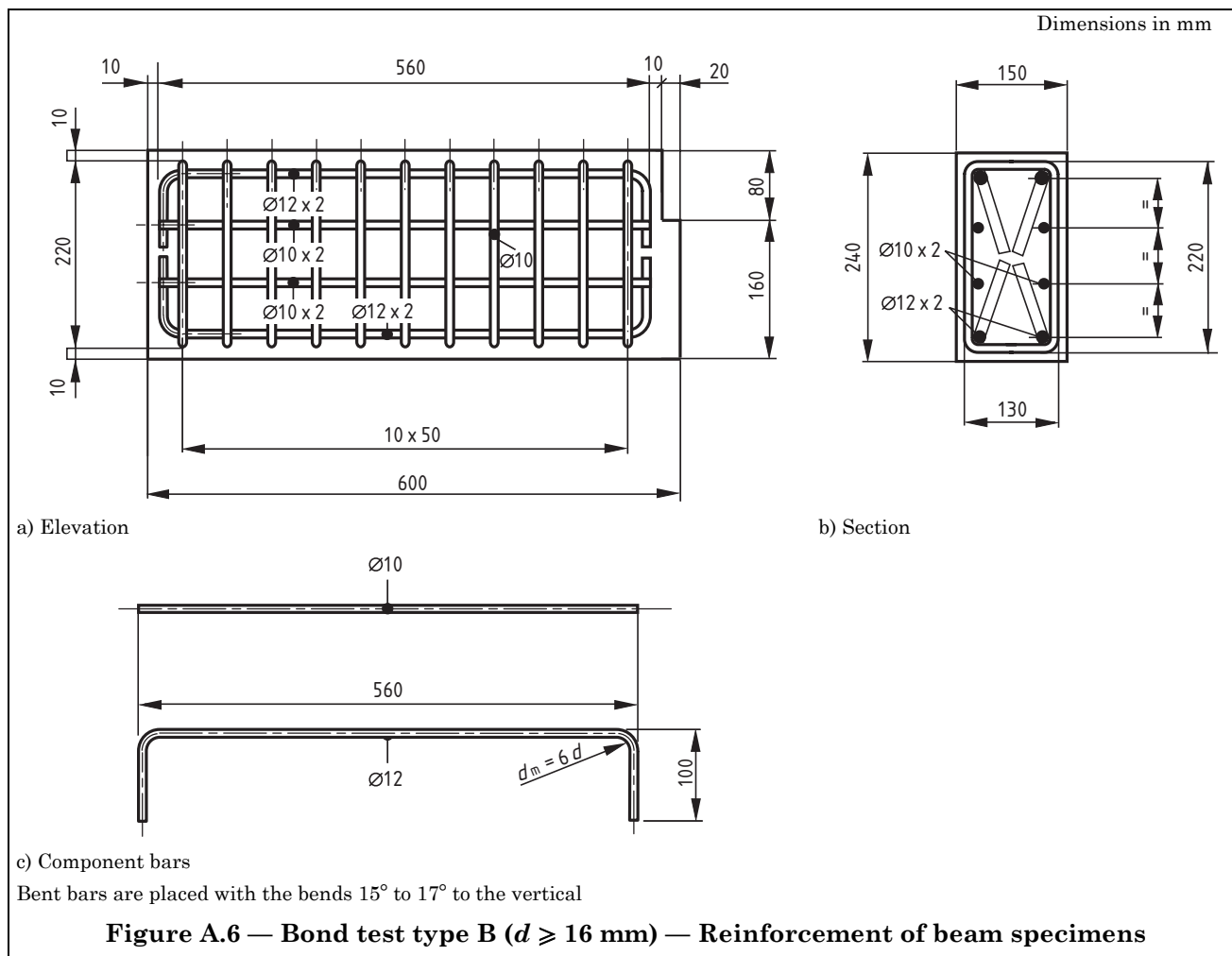

A.6 Execution of the tests

Resting the test beam on two rotating knife-edges or rolling bearings, load with two forces of equal magnitude, disposed symmetrically with regard to mid-span and likewise applied through movable knife-edges or rollers.

The total force, F_a applied to the test piece is given by one of the following expressions:

$$F_a = \frac{A_n \sigma_s}{1.25}, \text{ for } d < 16 \text{ mm}$$

$$F_a = \frac{A_n \sigma_s}{1.50}, \text{ for } d \geq 16 \text{ mm}$$

where

A_n is the nominal cross-sectional area of the reinforcing steel.

Apply loading in one of three ways:

- in consecutive increments corresponding to stresses, σ_s in the reinforcing steel of 0 MPa, 80 MPa, 160 MPa, 240 MPa, etc.;
- in smaller increments; or
- continuously, by logging with electronic devices.

For a) or b), increase the force, at each stage, gradually and continuously. Reach each increment in half a minute and maintain the load long enough to stabilize the slip, or, at the most, for two minutes. For c), use a loading speed not exceeding a corresponding stressing rate of 1 MPa/s in the reinforcing steel.

Measure the slip at the beginning and at the end of each increment in loading.

Continue the test until complete bond failure of the reinforcing steel occurs in both half-beams or until the reinforcing steel itself fails. Bond failure generally does not take place simultaneously in the two half-beams. For this reason, when the half of the reinforcing steel whose bond has failed attains a slip of 3 mm, hold this half-bar in a gripping device which will bear against the concrete and prevent any further slip.

Force-slip curves may be either recorded automatically, or plotted point by point from dial gauge readings.

A.7 Test results

A.7.1 Calculation of the bond stress

If the total force applied to the beam test is F_a , for a given slip, the bond stress, τ_b , is given by:

$$\tau_b = \frac{\tau_s}{40}$$

where

σ_s is the stress of the bar, given by one of the following formulae:

$$\sigma_s = \frac{1.25F_a}{A_n}, \text{ for } d < 16 \text{ mm}$$

$$\sigma_s = \frac{1.50F_a}{A_n}, \text{ for } d \geq 16 \text{ mm.}$$

A.7.2 Values of bond stress

Calculate the bond stress for four measured slip values:

- a) $\tau_{0.01}$ = Bond stress at 0.01 mm slip;
- b) $\tau_{0.1}$ = Bond stress at 0.1 mm slip;
- c) τ_1 = Bond stress at 1 mm slip; and
- d) τ_{bu} = Bond stress at maximum force.

Other values may be agreed between the parties.

To obtain the four values of slip, record force-slip curves. These shall be made available on request.

A.8 Test report

The laboratory shall issue a report which shall contain the following information:

- a) identification of the laboratory;
- b) identification of the manufacturer of the product tested;
- c) product number;
- d) technical class of the reinforcing steel with reference to the product specification;
- e) number of this standard (i.e. BS 4449:2005) and type of test method;
- f) nominal diameters tested and the series they represent;
- g) surface geometry of the specimen, i.e. rib/indentation heights, rib/indentation spacing, rib/indentation inclinations and relative rib/indentation area;
- h) strength class of the concrete, i.e. Type C(0,70) or Type C(0,45) according to BS EN 1766:2000;
- i) compressive strength of the concrete at the date of testing;
- j) dates of the tests;
- k) all single test results;
- l) description of the failure mode;
- m) force-slip curves.

Annex B (normative)

Material not covered by a third party product certification scheme

B.1 General

Material not covered by a third party product certification scheme shall be assessed by acceptance tests on each batch. Sampling and testing shall be carried out by an independent organization at the producer's works or in the stockholder's yard.

B.2 Extent of sampling and testing

For testing purposes, the batch shall be divided into test units with a maximum mass of 100 t. Each test unit shall comprise products of the same steel grade and nominal diameter from the same cast. The manufacturer shall certify that all products in the test unit originate from the same cast.

Test specimens shall be taken from each test unit as follows:

- a) fifteen specimens from different bars, for testing in accordance with **B.3a)** and **B.3b)**;
- b) two test specimens, from different bars, for testing in accordance with **B.3c)**.

Preparation of the test specimens shall be carried out as described in **7.2.2**.

B.3 Properties to be tested

Specimens selected in accordance with **B.2** shall be tested for the following.

a) *Inspection by variables:*

- 1) yield strength R_e ;
- 2) tensile/yield ratio R_m/R_e ;
- 3) total elongation at maximum force A_{gt} .

b) *Inspection by attributes:*

- 1) behaviour in the rebend test;
- 2) deviations from the nominal mass per metre;
- 3) bond strength and surface geometry.

c) *Chemical composition according to the product analysis.*

All elements listed in **7.1** and the carbon equivalent shall be determined.

d) *Fatigue properties:*

The fatigue properties of reinforcing steels shall be determined for each size and defined bar shape in the batch. Sampling and testing shall be carried out in accordance with **7.2.4**.

The test procedure shall be as described in Clause **9**.

B.4 Evaluation of results

B.4.1 Inspection by variables

Inspection by variables shall be carried out as follows:

- a) The following shall be determined for the performance characteristics listed in **B.3a**):
- 1) all individual values for each of the performance characteristics;
 - 2) the mean value m_{15} of each of the performance characteristics; and
 - 3) the standard deviation S_{15} for each performance characteristic.

The test unit shall be deemed to conform to this British Standard if the following conditions are met:

$$m_{15} - 2.33 \times S_{15} \geq cv \text{ for } R_e, \text{ and}$$

$$m_{15} - 1.87 \times S_{15} \geq cv \text{ for } R_m/R_e \text{ and } A_{gt}.$$

- b) If the conditions in a) are not fulfilled, a secondary calculation (the acceptability index k) shall be determined, where:

$$k = \frac{m_{15} - c_v}{S_{15}}$$

If $k \geq 2$ for R_e , and $k \geq 1.6$ for R_m/R_e and A_{gt} , testing shall continue. Forty-five further test specimens shall be taken and tested from different bars in the test unit, so that a total of 60 test results are available ($n = 60$).

The test unit shall be deemed to conform to this British Standard if the following conditions are fulfilled:

$$m_{60} - 1.93 \times S_{60} \geq c_v \text{ for } R_e, \text{ and}$$

$$m_{60} - 1.53 \times S_{60} \geq c_v \text{ for } R_m/R_e \text{ and } A_{gt}.$$

B.4.2 Inspection by attributes

Inspection by attributes shall be carried out as follows. When testing the properties listed in **B.3b**), either:

- a) all the results determined on the 15 test specimens shall conform to this standard; or
- b) if a maximum of two of the 15 results do not conform to this British Standard, 45 further test specimens shall be taken and tested from different bars in the test unit, making 60 test results available; the unit shall be deemed to conform to this British Standard if no more than two of the 60 test specimens fail the tests.

B.4.3 Fatigue properties

The batch shall be deemed to conform to this British Standard if it conforms to **7.2.4**.

B.5 Test report

A test report shall be produced containing the following data:

- a) the place of manufacture of the reinforcing steels;
- b) the nominal diameter of the steel;
- c) the grade of the steel;
- d) the marking on the steel;
- e) the cast number;
- f) the date of testing;
- g) the mass of the test unit; and
- h) the individual test results for all the properties specified in **B.3**.

Annex C (normative)

Identification requirements

C.1 Bar — Identification of the manufacturer

C.1.1 Each reinforcing steel shall bear on one rib row, a mark identifying the works. This mark shall be repeated at an interval of not more than 1.5 m.

C.1.2 The mark shall consist of the following:

- a) a symbol denoting the beginning of the mark;
- b) a numerical system identifying the manufacturer, consisting of the country of origin and the works number.

C.1.3 The numerical system identifying the manufacturer, consisting of a country number of origin and a works number shall use one of the following methods:

- a) a number of normal ribs between widened ribs (for example, see Figure C.1);
- b) a number of normal ribs between missing ribs;
- c) numbers on the surface of the bar;
- d) rolled or indented marks with a number of normal ribs in between them.

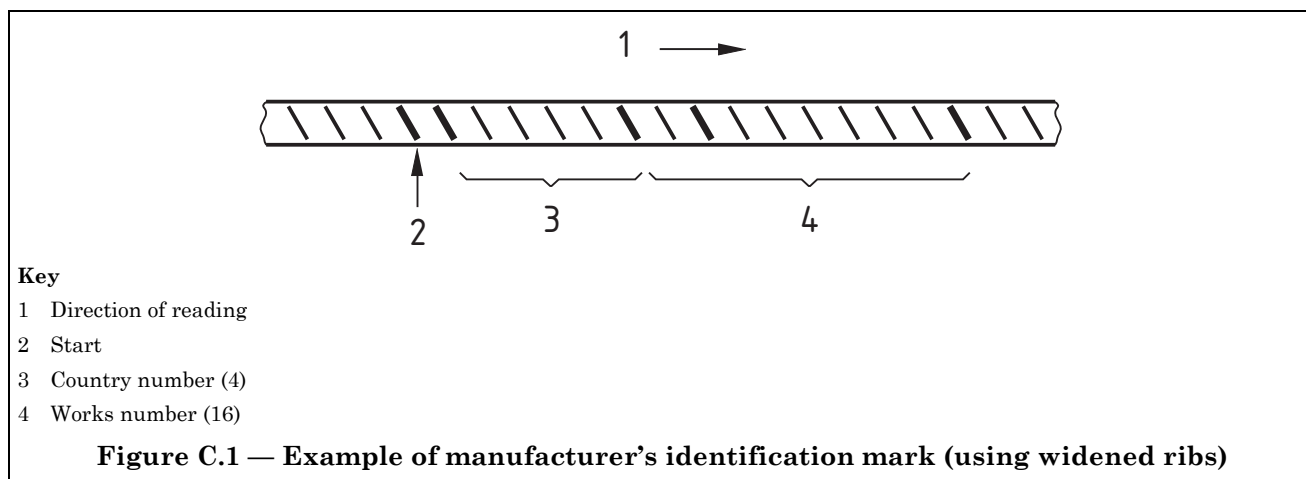

C.1.4 The symbol indicating the start of the mark shall be one of the following.

- a) Where the marking method uses widened ribs, the symbol identifying the start of the mark shall consist of two consecutive widened ribs (for example see Figure C.1).
- b) Where the marking method uses missing ribs, the symbol identifying the start of the mark shall consist of two consecutive missing ribs.
- c) Where numbers are rolled onto the surface of the bar, the symbol indicating the start of the mark shall be an X or O.
- d) Where marks are rolled or indented onto the surface, the start of the mark shall consist of a clearly identifiable starting symbol or two marks between one pair of normal ribs.

C.1.5 The country of origin shall be indicated by a number between 1 and 9, according to Table C.1 (for example see Figure C.1).

C.1.6 The works number shall consist of a one or two digit number between 1 and 99, except for multiples of 10 (for example, see Figure C.1).

Table C.1 — Identification of the country of origin

Country	Country number
Austria, Czech Republic, Germany, Poland, Slovakia	1
Belgium, Netherlands, Luxembourg, Switzerland	2
France, Hungary	3
Italy, Malta, Slovenia	4
UK, Ireland, Iceland	5
Denmark, Estonia, Finland, Latvia, Lithuania, Norway, Sweden	6
Portugal, Spain	7
Cyprus, Greece	8
Other countries	9

C.2 Coil

C.2.1 Coil shall be identified in the same manner as described in C.1 for bar.

C.2.2 For coil, the manufacturer's identification refers to the works applying the final mechanical properties to the coil product.

C.3 Decoiled product

C.3.1 In addition to the manufacturer's identification placed onto the product, an identification mark of the decoiler shall be either made on the product or printed on an attached label.

Bibliography

Standards publications

BS EN 1992-1-1:2004, *Eurocode 2: Design of concrete structures — General rules for buildings (together with United Kingdom National Application Document)*.

BS EN 13877-3, *Concrete pavements — Specifications for dowels to be used in concrete pavements*.

Other publications

[1] RILEM Publications SARL, *Recommendation RC5, Bond test for reinforcement steel — Beam test*, 2nd Ed. 1982. (www.rilem.org)

BSI — British Standards Institution

BSI is the independent national body responsible for preparing British Standards. It presents the UK view on standards in Europe and at the international level. It is incorporated by Royal Charter.

Revisions

British Standards are updated by amendment or revision. Users of British Standards should make sure that they possess the latest amendments or editions.

It is the constant aim of BSI to improve the quality of our products and services. We would be grateful if anyone finding an inaccuracy or ambiguity while using this British Standard would inform the Secretary of the technical committee responsible, the identity of which can be found on the inside front cover. Tel: +44 (0)20 8996 9000. Fax: +44 (0)20 8996 7400.

BSI offers members an individual updating service called PLUS which ensures that subscribers automatically receive the latest editions of standards.

Buying standards

Orders for all BSI, international and foreign standards publications should be addressed to Customer Services. Tel: +44 (0)20 8996 9001. Fax: +44 (0)20 8996 7001. Email: orders@bsi-global.com. Standards are also available from the BSI website at <http://www.bsi-global.com>.

In response to orders for international standards, it is BSI policy to supply the BSI implementation of those that have been published as British Standards, unless otherwise requested.

Information on standards

BSI provides a wide range of information on national, European and international standards through its Library and its Technical Help to Exporters Service. Various BSI electronic information services are also available which give details on all its products and services. Contact the Information Centre. Tel: +44 (0)20 8996 7111. Fax: +44 (0)20 8996 7048. Email: info@bsi-global.com.

Subscribing members of BSI are kept up to date with standards developments and receive substantial discounts on the purchase price of standards. For details of these and other benefits contact Membership Administration. Tel: +44 (0)20 8996 7002. Fax: +44 (0)20 8996 7001. Email: membership@bsi-global.com.

Information regarding online access to British Standards via British Standards Online can be found at <http://www.bsi-global.com/bsonline>.

Further information about BSI is available on the BSI website at <http://www.bsi-global.com>.

Copyright

Copyright subsists in all BSI publications. BSI also holds the copyright, in the UK, of the publications of the international standardization bodies. Except as permitted under the Copyright, Designs and Patents Act 1988 no extract may be reproduced, stored in a retrieval system or transmitted in any form or by any means – electronic, photocopying, recording or otherwise – without prior written permission from BSI.

This does not preclude the free use, in the course of implementing the standard, of necessary details such as symbols, and size, type or grade designations. If these details are to be used for any other purpose than implementation then the prior written permission of BSI must be obtained.

Details and advice can be obtained from the Copyright & Licensing Manager. Tel: +44 (0)20 8996 7070. Fax: +44 (0)20 8996 7553. Email: copyright@bsi-global.com.